

<b>System Model</b>	<b>ES-30-550</b>	
<b>System Performance</b>	<b>Metric</b>	<b>British</b>
<b>Rated Random/Sine Force</b>	30 kN	6600 lbf
<b>Rated Shock Force</b>	60/90* kN	13200/19800* lbf
<b>Usable Frequency</b>	5-2000 Hz	5-2000 Hz
<b>Maximum Velocity</b>	2/2.5* m/s	78.7/98.4* in/s
<b>Maximum Acceleration</b>	500 m/s <sup>2</sup>	50 g
<b>Maximum Payload</b>	500 kg	1100 lbs
<b>Resonance Frequency</b>	2200±5% Hz	2200±5% Hz
<b>Maximum Displacement p-p</b>	51 mm	2 in
<b>Shaker Model</b>	<b>ET-30</b>	
<b>Mass of Moving Elements</b>	55 kg	121 lbs
<b>Armature Diameter</b>	550 mm	21.7 in
<b>Weight</b>	About 2540 kg	About 5600 lbs
<b>Body Suspension Natural Frequency</b>	2.5 Hz	2.5 Hz
<b>Dimension L×W×H</b>	1288×852×1145 mm	50.7×33.5×45 in
<b>Power Amplifier Model</b>	<b>DA-30</b>	
<b>Power</b>	30 kVA	30 kVA
<b>Weight</b>	About 500 kg	About 1102 lbs
<b>Power Supply Requirement</b>	48 kVA	48 kVA
<b>Dimension L×W×H</b>	545×840×1750 mm	21.5×33×69 in
<b>Cooling Type</b>	<b>Air Cooling</b>	
<b>Blower Model</b>	<b>B-3000</b>	
<b>Power</b>	7.5 kW	10.06 hp
<b>Air Flow</b>	0.46 m <sup>3</sup> /s	460 l/s
<b>Air Pressure</b>	8.8 kPa	1.276 psi
<b>Weight</b>	180 kg	397 lbs

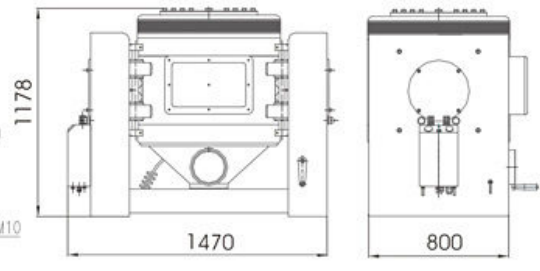

Shaker ET-30-550

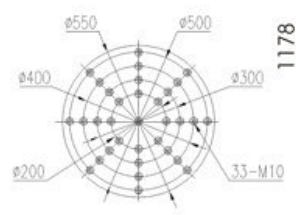

Power Amplifier DA-30

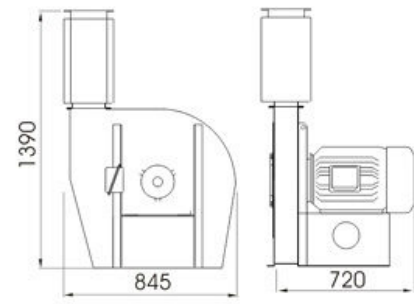

Blower B-3000